

VOLKTEK

Hawkeye 7160-7GP1GT-24V-I

Premium Unmanaged 7 x 10/100/1000 PoE+ & 1 x 10/100/1000 RJ45 Industrial Switch

Description

The Hawkeye 7160-7GP1GT-24V-I is a Premium unmanaged PoE+ switch, which is equipped with eight 10/100/1000BASE-T ports. It's a very cost-effective, and future-proof industrial-grade switch. The Hawkeye 7160-7GP1GT-24V-I is a full Gigabit Ethernet switch supporting IEEE 802.3at/802.3af on ports 1 to 7. It is classified as power source equipment (PSE), provides up to 30 watts per specific port, and reduces the effort needed to install power. The switch can be used to power IEEE 802.3at/af standard powered devices (PD) and provide an economical high-bandwidth solution for your industrial Ethernet network. The Hawkeye 7160-7GP1GT-24V-I supports a wide range of power inputs. It means it can support PoE operation in different field applications.



Features Highlight

High-Power Budget for PoE Network Devices

The Hawkeye 7160-7GP1GT-24V-I is capable of delivering PoE power up to 30W per port (IEEE 802.3af/at) to PoE+ compliant powered devices. Addition to this, the switch allows simple “plug and play” PoE for various types of high power consuming PoE devices. Thereby, irrespective of their location, powered devices can be powered without installing additional power outlets or cabling and significantly reduce your CAPEX.

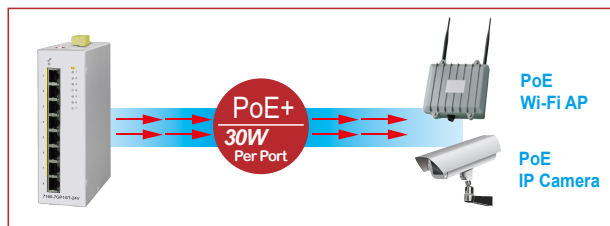

Intelligent VLAN Data Forwarding

The Hawkeye 7160-7GP1GT-24V-I is aware enough to read the source and destination of VLAN tagged data packets. This unmanaged switch delivers VLAN packets without changing or dropping them assuring operational data in industrial fields is delivered safely across devices.

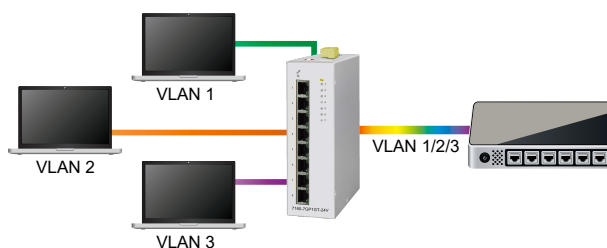

Traffic Control Mechanisms to Optimize Bandwidth Usage

Traffic control mechanisms regulate excessive traffic to avoid delay, data loss and connection issues between devices. The Hawkeye 7160-7GP1GT-24V-I offers mechanisms such as Flow and Storm Control that prevent devices from overwhelming each other during the exchange of data and to keep the flux at a tolerable rate, hence keeping devices working within their capacity and avoiding the network from collapsing.

Critical Data Transmission Priority

The Hawkeye 7160-7GP1GT-24V-I streamlines the execution of time-sensitive applications with the 802.1p Tag QoS by classifying data into high and low priority. Furthermore, when it comes to mission-critical applications in industrial automation, you can count on seamless performance without any interruptions.

This is achieved through port prioritization on ports #1 and #2, ensuring these crucial tasks are given top priority even during periods of high network traffic.

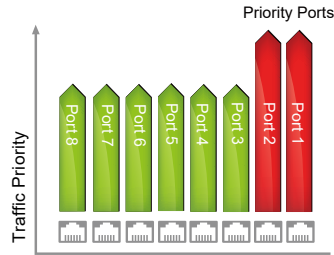

Prioritizes Industrial Standard Protocols

This Premium unmanaged switch is equipped with iQoS (Intelligent Quality of Service) to ensure that industrial application protocols receive top priority. It prioritizes the delivery of data crucial for industrial applications, including Ethernet/IP, PROFINET, and GOOSE (Generic Object Oriented Substation Events). This means that these essential protocols are given precedence to ensure smooth and reliable operation in industrial settings.

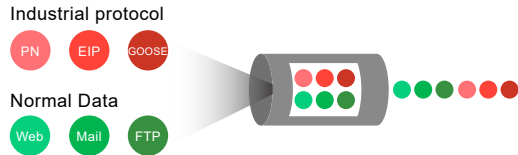

Connects Large Network Groups and Facilitates Data for Monitoring Systems

During network discovery unmanaged switches can cause device flapping and make it difficult for monitoring systems to access device data. The Hawkeye 7160-7GP1GT-24V-I avoids device flapping when connected to a managed switch. Using the LLDP Filter feature the device can be used in large networks. It allows other devices in the network to exchange identifiable data for accurate monitoring without concerns from detecting erroneous messages and false alerts in the presence of an unmanaged switch.

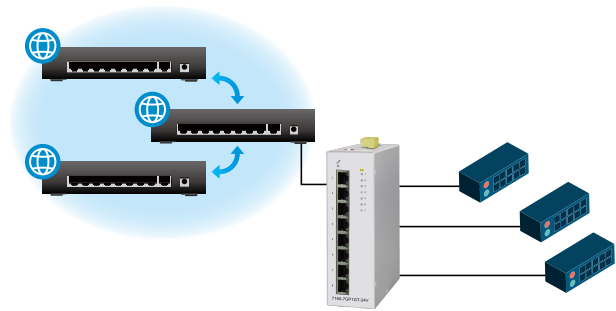

Eco-friendly Green Ethernet Design

Reducing our energy consumption not only puts more money in your pocket but also contributes to a greener planet by reducing our carbon footprint.

To tackle the growing concerns about rising power usage, the Hawkeye 7160-7GP1GT-24V-I incorporates the environmentally-friendly IEEE 802.3az Energy Efficient Ethernet (EEE) compliant Green Ethernet technology. Thanks to its Dip switch design, this switch can adapt its power consumption, conserving energy when data activity is low. This not only helps you significantly reduce your energy bills but also contributes to your efforts in being environmentally conscious. Moreover, it provides a visual indicator that clearly shows the switch's status, making it easier for you to understand how the circuit is functioning.

Applications

Sufficient PoE Power with Easy Uplink to Control Room

The Hawkeye 7160-7GP1GT-24V-I combines with 7-port high-power PoE+, robust performance for surveillance systems in harsh environments. With its highly reliable and secure features ensure continuous operations in some special requirements for transportation, factory and outdoor places where high vibration degree, shock and wide range temperatures are present. Addition to this the Gigabit port without PoE helps to uplink the real-time data and video to the control room without any interruption.

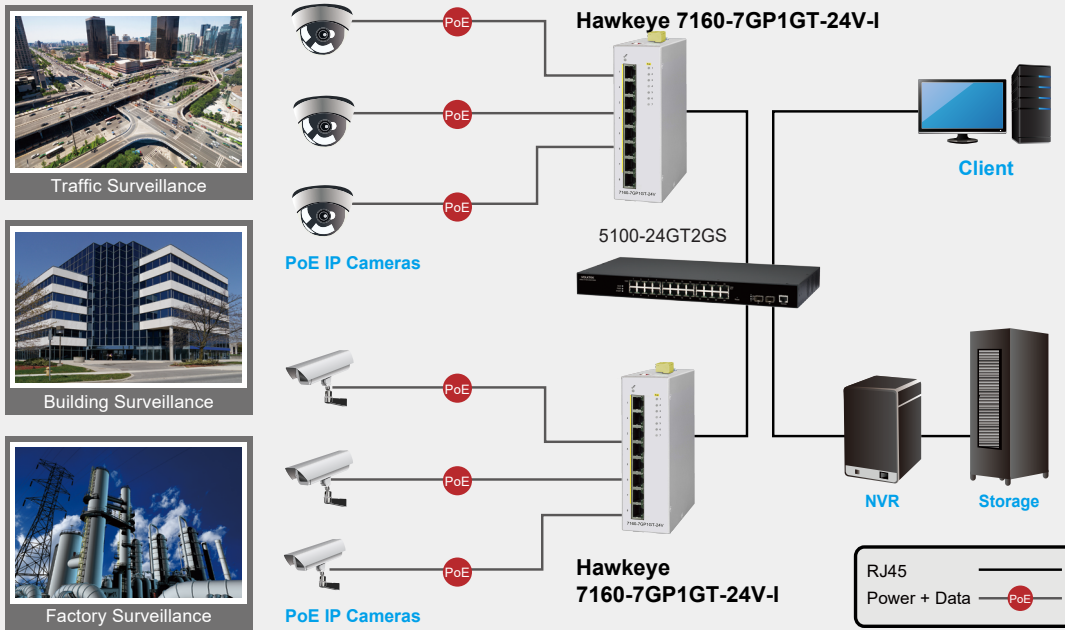

Sufficient PoE Power with Easy Uplink to Control Room

The Hawkeye 7160-7GP1GT-24V-I combines with 7-port high-power PoE+, robust performance for surveillance systems in harsh environments. With its highly reliable and secure features ensure continuous operations in some special requirements for transportation, factory and outdoor places where high vibration degree, shock and wide range temperatures are present. Addition to this the Gigabit port without PoE helps to uplink the real-time data and video to the control room without any interruption.

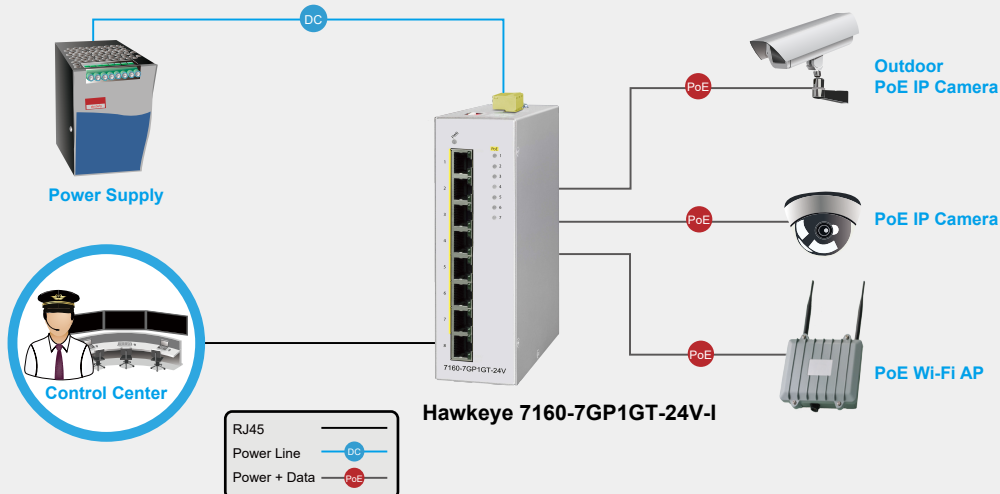

Specifications

Standards	
IEEE 802.3	10BASE-T
IEEE 802.3u	100BASE-TX
IEEE 802.3ab	1000BASE-T
IEEE 802.3	Nway Auto-negotiation
IEEE 802.3x	Flow Control
IEEE 802.3af	Power over Ethernet (PoE)
IEEE 802.3at	Power over Ethernet (PoE+)
IEEE 802.1p	Class of service
IEEE 802.3az	EEE
Interface	
Ports	7 x 10/100/1000BASE-T (PoE RJ45) 1 x 10/100/1000BASE-T Port
DIP Switch	Flow Control, Storm Control, EEE, LLDP Filter
LED Panel	PWR, 1000, LNK/ACT, PoE
Features	
Performance	Jumbo Frames Size: 9Kbytes
	MAC Table Entries: 4K
	Active VLAN: 4K
	Switching Fabric: 16Gbps
Forwarding Rate: 11.9Mpps	
Functions	Flow Control, Storm Control, LLDP Filter, VLAN Passthru, Port Priority (p1-2), 802.1p/Tag QoS, EIP QoS (via TCP/UDP #), PROFINET QoS (via VLAN 0), GOOSE QoS (via Ether-type)
Power	
Input Voltage	24~57VDC
	System: 17W
Power Consumption	PoE Power Budget: 210W@48VDC, 120W@24VDC

Mechanical and Environment		
Housing	Metal Case (IP40 protection)	
Mounting	DIN-Rail	
Operating Temperature	-10°C~60°C (14°F~140°F)	
Storage Temperature	-40°C~85°C (-40°F~185°F)	
Operating Humidity	5 to 95% RH (non-condensing)	
Storage Humidity	5 to 95% RH (non-condensing)	
Weight	1,005g	
Dimension (WxHxD)	50 x 160 x 120mm (1.97 x 6.3 x 4.72in)	
Certifications (Processing)		
CE	EMI	FCC Part 15 Subpart B Class A EN 55032 / UKCA Class A CISPR 32 Class A EN 55011 / UKCA Class A CISPR 11 Class A EN 61000-6-4 / UKCA ICES-003 Issue 7
	EMS	EN55035 / UKCA EN 61000-6-2 / UKCA EN 61000-4-2 (ESD) EN 61000-4-3 (RS) EN 61000-4-4 (EFT) EN 61000-4-5 (Surge) EN 61000-4-6 (CS) IEC 61000-4-8 (PFMF)
Safety	UL 61010-1 / UL 61010-2-210	
Freefall Test	IEC 60068-2-31	
Ordering Information		
Hawkeye	Premium Unmanaged 7 x 10/100/1000 PoE+ & 1 x 10/100/1000 RJ45 Industrial Switch	
Optional Accessories		
Power Supply	SDR-240-48: DIN-Rail, 240W, 48VDC, Industrial Power Supply with PFC Function	

Note:

* The SFP communication distance upon the request.

* Industrial SFP with wide operating temperature from -40°C~85°C (-40°F~185°F) is available upon request.

* Specifications subject to change without notice.

Dimension

